

WAGNER

PROMOS FEBRERO - SEPTIEMBRE 2026



CHANGE it.

MaKimport
Makimport Herramientas, S.L.

TRADICIÓN, PRODUCTIVIDAD E INNOVACIÓN

www.grupocevik.es

SISTEMA DE PINTURA AIRLESS

BARNICES
LACAS
DISPERSIÓN



SPRAYPACK 18 V KIT

CAUDAL MÁX.	0.9 l/min
PRESIÓN MÁX.	110 bar
DEPÓSITO	4.7 L.
MANGUERA MÁX.	15 m.
BOQUILLA MÁX.	0.017"



WÄGNER
999,00 €
Ref.: WG-2466025



CARGADOR Y BATERÍA INCLUIDO
** BATERÍA GAMA BOSCH AZUL PROCORE

**REGALO
SUDADERA**



BOMBAS ELÉCTRICAS DE PISTÓN

HEA HIGH EFFICIENCY AIRLESS

POWER PAINTER 90 SKID



200 bar.

0,019"

1,6 L. / min.

WAGNER

999,00 €

Ref.: WG-2414079

POWER PAINTER 90 EXTRA



200 bar.

0,019"

1,6 L. / min.

WAGNER

1199,00 €

Ref.: WG-2401275

REGALO SUDADERA

PROSPRAY 3.20



207 bar.

0,021"

1,6 L. / min.

WAGNER

1499,00 €

Ref.: WG-2412438

REGALO SUDADERA

PROSPRAY 4.23 HEA SPRAYPACK



228 bar.

0,023"

2,1 L. / min.

WAGNER

2999,00 €

Ref.: WG-2435373

PROSPRAY 3.31 CONNECT



221 bar.

0,032"

5 L. / min.

WAGNER

5879,00 €

Ref.: WG-2420184

PROSPRAY 3.39 CONNECT MASILLAS



221 bar.

0,039"

5 L. / min.

WAGNER

6999,00 €

Ref.: WG-2420185

BOMBAS ELÉCTRICAS DE MEMBRANA

HEA HIGH EFFICIENCY AIRLESS

SUPER FINISH 21 PRO LACAS



207 bar.

0,021"

2,1 L. / min.

WAGNER

1499,00 €

Ref.: WG-2437312

REGALO SUDADERA

SUPER FINISH 21 PRO HEA



207 bar.

0,021"

2,1 L. / min.

WAGNER

1499,00 €

Ref.: WG-2437311

REGALO SUDADERA

SUPER FINISH 23 CR



250 bar.

0,023"

2,6 L. / min.

WAGNER

2939,00 €

Ref.: WG-2415601

SUPER FINISH 23 PRO HEA



250 bar.

0,023"

2,6 L. / min.

WAGNER

2199,00 €

Ref.: WG-2399198

REGALO SUDADERA

SUPER FINISH 33 PLUS



250 bar.

0,033"

4,3 L. / min.

WAGNER

5999,00 €

Ref.: WG-2388259

SUPER FINISH 33 PRO



250 bar.

0,033"

4,3 L. / min.

WAGNER

5999,00 €

Ref.: WG-2388260

BOMBAS HIDRÁULICAS DE PISTÓN

HEAVY COAT 970 VERSIÓN ELÉCTRICA



250 bar.
0,056"
10,3 L. / min.

WAGNER

CONSULTAR

Ref.: WG-2332191

SSP

VERSIÓN ELÉCTRICA
Ref.: WG-2332193

VERSIÓN GASOLINA
Ref.: WG-2332192

HEAVY COAT 950 VERSIÓN ELÉCTRICA



250 bar.
0,052"
6,6 L. / min.

WAGNER

CONSULTAR

Ref.: WG-2332184

SSP

VERSIÓN ELÉCTRICA
Ref.: WG-2332187

VERSIÓN GASOLINA
Ref.: WG-2332186

BOMBA HELICOIDAL



PLAST COAT 1030E



40 bar.
GRANULOMETRIA 16 mm.
15 L. / min.

WAGNER

CONSULTAR

Ref.: WG-2361588

**ESPECIAL
SATE**

TURBINAS XVLP/HVLP

**FINISH CONTROL
4000 18V STANDARD XVLP**



0,20 bar.

1.000 ml.

370 W.

Autonomía aproximada de 25 minutos (dependiendo del tipo de material)

WAGNER

681,00 €

Ref.: WG-2437348

Ref.: WG-SETCARG3BAT PVP: 259€

DISPONIBLE CARGADOR + 3 BATERÍAS

**FINISH CONTROL
4000 18V FINE SPRAY XVLP**



0,20 bar.

1.000 ml.

370 W.

WAGNER

950,00 €

Ref.: WG-2437240



**FINISH CONTROL
5500 XVLP**



0,29 bar.

1.000 ml.

1,150 W.

Posibilidad de adaptar diferentes frontales y envases originales

WAGNER

799,00 €

Ref.: WG-2422986

FRONTAL STANDARD INCLUIDO

**FINECOAT
9700 HVLP**



0,30 bar.

300 hpa.

1,150 W.

WAGNER

799,00 €

Ref.: WG-2426601





FRONTALES

<p>ESPECIAL LACAS Y ESMALTES</p> 	<p>ESPECIAL PAREDES</p> 	<p>UNIVERSAL</p> 	
<p>Frontal Fine Spray</p> <p>125,00 € Ref.: WG-2430385</p>	<p>Frontal Wall Spray</p> <p>125,00 € Ref.: WG-2430387</p>	<p>Frontal Estándar Spray</p> <p>125,00 € Ref.: WG-2430386</p>	<p>Adaptador Envases</p> <p>54,00 € Ref.: WG-2350692</p>

KITS PARA FRONTAL FINE COAT

KITS	REFERENCIA
No. 2, Ø 0,8 mm.	WG-276254
No. 3, Ø 1,3 mm.	WG-276227
No. 4, Ø 1,8 mm.	WG-276228
No. 5, Ø 2,2 mm.	WG-276229
No. 6, Ø 2,5 mm.	WG-276245
No. 7, Ø 2,7 mm.	WG-524211

79,00 €

PISTOLA CON DEPÓSITO DE GRAVEDAD



600 ML.

360,00 €
Ref.: WG-524053

BOQUILLAS AIRLESS

BOQUILLA TRADE TIP3 AIRLESS



CARBURO TUNGSTENO

46,00 €
Ref.: WG-553+ N° IMPAR

BOQUILLA TRADE TIP3 FINE FINISH



CARBURO TUNGSTENO

55,00 €
Ref.: WG-554 + N° PAR

BOQUILLA SPEED TIP 2 AIRLESS



DOBLE ANCHO DE ABANICO
CARBURO TUNGSTENO

70,00 €
Ref.: WG-271

BOQUILLA HEA PRO TIP



CARBURO TUNGSTENO

68,00 €
Ref.: WG-554+ N° IMPAR

DISPOSITIVO BOQUILLA



BOQUILLAS
TRADE TIP 3

57,00 €
Ref.: WG-289390

ROSCA G
7/8 "

PROLONGADOR DE BOQUILLAS

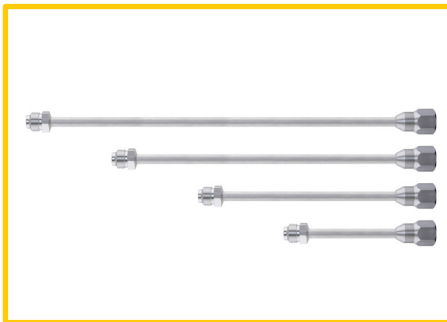

REFERENCIA	MEDIDA	PRECIO
WG-2418836	12 cm	32 €
WG-2418839	25 cm	39 €
WG-2418840	50 cm	51 €
WG-2418841	75 cm	65 €

FILTROS

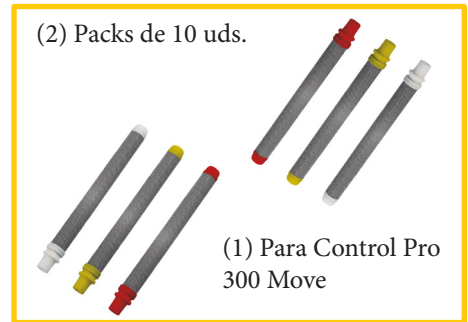

WG-97022 (2)	ROJO	30 €
WG-97024 (2)	BLANCO	30 €
WG-97023 (2)	AMARILLO	30 €
WG-2450276 (1)	ROJO	24 €
WG-2450281 (1)	BLANCO	24 €
WG-2450282 (1)	AMARILLO	24 €

PISTOLAS AIRLESS / AIRCOAT

AC4500



681,00

Ref.: WG-2368271

AC4600



919,00

Ref.: WG-394157

VECTOR PRO



4 DEDOS

293,00

Ref.: WG-538040

VECTOR PRO



2 DEDOS

293,00

Ref.: WG-538041

AG14



407,00

Ref.: WG-502081A

AG19



536,00

Ref.: WG-2341127

VECTOR GRIP



2 DEDOS



4 DEDOS

INCLUYE
GATILLO 2/4
DEDOS Y
EMPUÑADURA
MEDIANA

406,00

Ref.: WG-538043

MANGUERAS AIRLESS

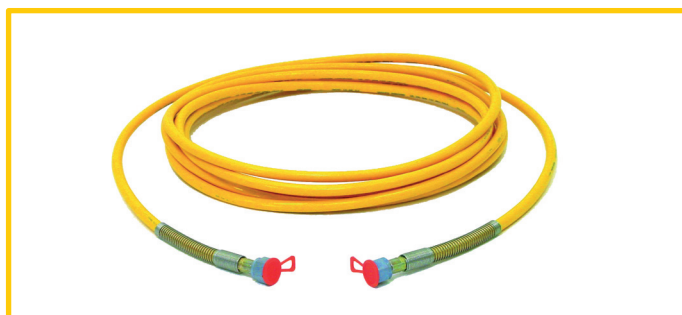

MANGUERAS AIRCOAT

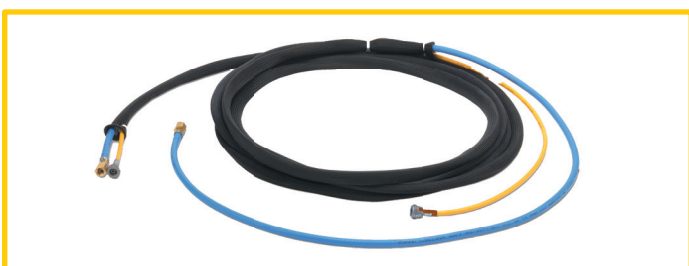

AP	REFERENCIA	PRECIO
NW327 - 27 MPA -NPS 1/4"- 7,5 M.	WG-9984583	116,00 €
NW4 - 25 MPA - NPS 1/4" - 7,5 M.	WG-9984573	131,00 €
NW6 - 25 MPA - NPS 1/4" - 15 M.	WG-9984574	209,00 €
NW10 - 25 MPA - NPSM 3/8" -15 M.	WG-2336583	293,00 €

DOBLE AP	REFERENCIA	PRECIO
DN3 - AIRE DN6 - 1/4" - 7,5 M.	WG-9984595	240,00 €
DN4 - AIRE DN6 - 1/4" - 10 M.	WG-2302379	269,00 €

LÍQUIDOS DE MANTENIMIENTO

TIP CLEAN DISOLVENTE



34,00 €

Ref.: WG-2400216

EASY CLEAN LIMPIEZA



24,00 €

Ref.: WG-2475524

TIP CLEAN DEPÓSITO BOQUILLAS



26,00 €

Ref.: WG-2400214

EASY GLIDE ACEITE ESPECIAL



13,00 €

Ref.: WG-508619

MODO DE EMPLEO

1.



Abra la tapa y coloque hasta 6 boquillas airless TradeTip en el recipiente.

2.



Cierre la tapa y gire el recipiente boca abajo. Deje que las boquillas se sumerjan en el agente limpiador.

3.



Sacudiendo el contenedor, la suciedad y los residuos de pintura se despegan. Dejar reposar las boquillas en el agente de limpieza.

4.



El agente de limpieza fluye por el contenedor. Abra la tapa, retire las boquillas y retire el residuo con un cepillo. O deje actuar hasta el próximo uso.



ACCESORIOS DE PINTURA

PARA MODELO
SF23 - 5 L.



WAGNER

104,00 €

Ref.: WG-341265

PARA MODELO
SF21 - 3,7 L.



WAGNER

104,00 €

Ref.: WG-2444212

PARA MODELO
PP90 EXTRA - 5 L.



WAGNER

209,00 €

Ref.: WG-2423122

VÁLVULA
ANTI-SALPICADURAS



WAGNER

155,00 €

Ref.: WG-2459770

RACOR "Z"
FLEXTWIST Z



WAGNER

155,00 €

Ref.: WG-2454974

EVITA LA
TORSIÓN

SET 5 JUNTAS
ANTI-SALPICADURAS

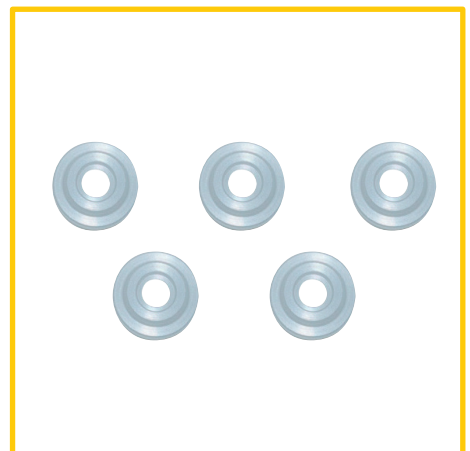

WAGNER

112,00 €

Ref.: WG-2468382



GAMA INDUSTRIA

COBRA 40-10 AIRCOAT



WAGNER

CONSULTAR

Ref.: WG-322112

PRESIÓN DE AIRE (bar)	2,5 - 6
PRESIÓN MÁX. FLUIDO (bar)	250
CAUDAL MÁX. (l/min)	2
RATIO PRESIÓN	40:1
VOLUMEN POR CICLO (cm ³)	10
TAMAÑO MÁX. BOQUILLA	0,023"

INCLUYE: BOMBA DE MEMBRANA, DEPÓSITO 5L, MANGUERA DN3 DE 7,5 M, PISTOLA AC 4600, BOQUILLA 11/40 Y REGULADOR AC.

ZIP 52



WAGNER

CONSULTAR

Ref.: WG-2309669

PRESIÓN DE AIRE (bar)	1 - 8
PRESIÓN MÁX. FLUIDO (bar)	8
CAUDAL MÁX. (l/min)	52
RATIO PRESIÓN	1:1

INCLUYE: BOMBA DE DOBLE MEMBRANA, DEPÓSITO 5 L., MANGUERA DE 7,5 M., PISTOLA PRESIÓN Y SOPORTE PATAS.

Ref.: WG-2301838



Ref.: WG-2301832



**VERSIONES
DISPONIBLES**

PUMA 28-40 AIRLESS



WAGNER
CONSULTAR
 Ref.: WG-2303397

PRESIÓN DE AIRE (bar)	2 - 8
PRESIÓN MÁX. FLUIDO (bar)	224
CAUDAL MÁX. (l/min)	2,4
RATIO PRESIÓN	28:1
TAMAÑO MÁX. BOQUILLA	0,023"

INCLUYE: BOMBA PISTÓN DE SUCCIÓN, MANGUERA DN4 DE 7,5 M., PISTOLA AG14, BOQUILLA 512, FILTRO DN6 PINTURA Y SOPORTE 4 PATAS

Ref.: WG-2301854



**VERSIÓN
 DISPONIBLE**

PUMA 28-40 AIRCOAT



WAGNER
CONSULTAR
 Ref.: WG-367168

PRESIÓN DE AIRE (bar)	2,5 - 8
PRESIÓN MÁX. FLUIDO (bar)	224
CAUDAL MÁX. (l/min)	2,4
RATIO PRESIÓN	28:1
TAMAÑO MÁX. BOQUILLA	0,023"

INCLUYE: BOMBA PISTÓN DE SUCCIÓN, MANGUERA AC DE 7,5 M., PISTOLA AC 4600, BOQUILLA 11/14, REGULADOR AC Y SOPORTE 4 PATAS

Ref.: WG-367167

Ref.: WG-2301854



**VERSIONES
 DISPONIBLES**

FINEFINISH 40-15 S AIRLESS



WAGNER
CONSULTAR
 Ref.: WG-2309804

PRESIÓN DE AIRE (bar)	2 - 7
PRESIÓN MÁX. FLUIDO (bar)	250
CAUDAL MÁX. (l/min)	0,9
RATIO PRESIÓN	40:1
TAMAÑO MÁX. BOQUILLA	0,013"

INCLUYE: BOMBA PISTÓN FF40-15,5 DE SUCCIÓN, MANGUERA DN4 DE 7,5 M., PISTOLA AG14, BOQUILLA 512 Y LLAVE DE BOLA

Ref.: WG-2363202



**VERSIÓN
 DISPONIBLE**

FINEFINISH 20-30 S AIRCOAT



WAGNER
CONSULTAR
 Ref.: WG-2309802

PRESIÓN DE AIRE (bar)	2 - 8
PRESIÓN MÁX. FLUIDO (bar)	160
CAUDAL MÁX. (l/min)	1,8
RATIO PRESIÓN	20:1
TAMAÑO MÁX. BOQUILLA	0,019"

INCLUYE: BOMBA PISTÓN FF20-30 DE SUCCIÓN, MANGUERA AC DE 7,5 M., PISTOLA AC 4600, RETORNO, BOQUILLA, LLAVE DE BOLA Y REGULADOR AC.

Ref.: WG-2309799



**VERSIÓN
 DISPONIBLE**



CLICK & PAINT

TURBINA A BATERÍA

W250

0-250 ml/ min.

18 V

0,20 bar

Batería y cargador no incluidos

WAGNER

89,95 €

Ref.: WG-2457703

* Compatible con BATERIA BOSCH ALL 18 V SYSTEM



SET CARGADOR Y BATERÍA

60 €

Ref.: WG-2448616

GAMA CONSUMER

PRODUCTOS PENSADOS PARA TUS PROYECTOS PERSONALES

Leyenda



ESPECIAL PARA APLICACIÓN DE ESMALTES, LACAS Y BARNICES



ESPECIAL PARA APLICACIÓN DE PINTURAS PLÁSTICAS



SISTEMA AIRLESS DE BAJA PRESIÓN

TECNOLOGÍA

CLICK & PAINT



SISTEMAS DE PINTURA AIRLESS



HEA HIGH EFFICIENCY AIRLESS

PRODUCTOS BASE AGUA

CONTROL PRO 150 M



0,9 L. / min.
Manguera 7,5 m.
300 W.
Boquillas 311-515 incluidas

339,00 €

Ref.: WG-2394312

WAGNER

CONTROL PRO 300 MOVE 18V



Depósito 4,7 L.
0,9 L. / min.
Manguera 7,5 m.
300 W.
Boquillas 311-515 incluidas

699,00 €

Ref.: WG-2443925

WAGNER

INCLUYE: BATERÍA Y CARGADOR

CONTROL PRO 275 M



1,25 L. / min.
Manguera 9 m.
550 W.
Boquillas 311-517 incluidas

469,00 €

Ref.: WG-2443409

WAGNER

REGALO
SUDADERA

CONTROL PRO 250 R



1,25 L. / min.
Manguera 9 m.
550 W.
Boquillas 311-517 incluidas

479,00 €

Ref.: WG-2371069

WAGNER

CONTROL PRO 350 R



1,50 L. / min.
Manguera 15 m.
600 W.
Boquillas 311-517 incluidas

599,00 €

Ref.: WG-2371073

WAGNER

CONTROL PRO 350 M



1,50 L. / min.
Manguera 15 m.
600 W.
Boquillas 311-517 incluidas

649,00 €

Ref.: WG-2371057

WAGNER

DECAPADORES

FURNO 100



230 / 360 °C
100-150 L./min.

350 W.

2 Niveles de temperatura

25,00 €

Ref.: WG-2398546

WAGNER

FURNO 300



400 / 575 °C
675 L./min.

1.600 W.

2 Niveles de temperatura

29,00 €

Ref.: WG-2359348

WAGNER

FURNO 500

AUTO ENFRIAMIENTO



60/600 °C

800 L./min.

2.000 W.

12 Niveles de temperatura

51,00 €

Ref.: WG-2359352

WAGNER



FURNO 750



50 / 650 °C

820 L./min.

2.000 W.

Display Digital

INCLUYE MALETÍN



81,00 €

Ref.: WG-2359358

WAGNER

AUTO ENFRIAMIENTO

ACCESORIOS INCLUIDOS



SISTEMAS DE PINTURA



* Compatibles con BATERÍA BOSCH ALL 18 V SYSTEM
Ref.: WG-2448616
PVP: 60 €

W100



CLICK & PAINT

800 ml.
280 W.

88,00 €

Ref.: WG-2361507

WAGNER

W600 (A BATERÍA)



CLICK & PAINT

* BATERÍA NO INCLUIDA

1300 / 800 ml.
5 m² / 10 min.
20 V.

189,00 €

Ref.: WG-2420174

WAGNER

W510



CLICK & PAINT

1300 / 800 ml.
5 m² / 6 min.
460 W.

125,00 €

Ref.: WG-2402017

WAGNER

W690 FLEXIO



CLICK & PAINT

800 ml. LACAS Y BARNICES
1.800 ml. PINTURA PARED
15 m² / 6 min.
Manguera 3,5 m.
630 W.

169,00 €

Ref.: WG-2361543

WAGNER

W975 FLEXIO



CLICK & PAINT

800 ml.
15 m² / 5 min.
630 W.
Manguera 3 m.

SET DE LIMPIEZA INCLUIDO

SUCCIÓN DIRECTA

269,00 €

Ref.: WG-2454265

WAGNER

ACCESORIOS FRONTALES

FRONTAL STANDARD



800 ml

24,00 €

Ref.: WG-2361730

WAGNER

FRONTAL CORNER



600 ml

24,00 €

Ref.: WG-2361742

WAGNER

FRONTAL DETAIL



250 ml

27,00 €

Ref.: WG-2361744

WAGNER

FRONTAL LARGE



1.400 ml

24,00 €

Ref.: WG-2361736

WAGNER

FRONTAL BRILLIANT



600 ml

24,00 €

Ref.: WG-2361738

WAGNER

FRONTAL EXTRA I-SPRAY



1.300 ml

38,00 €

Ref.: WG-2361746

WAGNER

FRONTAL EXTRA I-SPRAY



1.800 ml

40,00 €

Ref.: WG-2361749

WAGNER

FRONTAL GRAVEDAD



150 +
600 ml

35,00 €

Ref.: WG-2412884

WAGNER



www.grupocevik.es



#sacatuladopro

Profesionales trabajando
para Profesionales



#SACATULADOPRO #sacatuladopro

COMPRESORES



PR06XS

- 230 V - 1 HP
- 8 Bar - 156 Lt/min
- 6 Litros

**EXTREME
SERIES**



109,00 €

Silencioso

Ref.: CA-PR06XS



PR027XS

- 230 V. - 2 HP
- 8 Bar - 230 Lt/min
- 24 Litros

**EXTREME
SERIES**



149,00 €

Silencioso

Ref.: CA-PR027XS



PR052XS

- 230 V - 2 HP
- 8 Bar - 230 Lt/min
- 50 Litros

**EXTREME
SERIES**



189,00 €

Silencioso

Ref.: CA-PR052XS



PR053XS

- 230 V - 4 HP
- 8 Bar - 420 Lt/min
- 50 Litros

**EXTREME
SERIES**



269,00 €

Silencioso

Ref.: CA-PR053XS

PR025-3MF

- 230 V - 3 HP
- 10 Bar
- 365 Lt/min
- 24 Litros



599,00 €

Ref.: CA-PR025-3MF

CONSULTA
TODA LA
GAMA

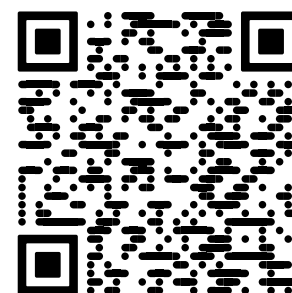

COMPRESORES

C330/03PRO



- 230 V - 3 HP
- 10 Bar - 330 Lt/min
- 1.400 RPM
- 3 Litros



PRO590M



- 230 V - 4 HP
- 10 Bar - 590 Lt/min
- 1.420 RPM
- 20 Litros



PRO200-4MF



- 230 V - 4 HP
- 10 Bar - 539 Lt/min
- 1.400 r.p.m.
- 200 Litros



999,00 €

Ref.: CA-C330/03PRO

Ciclo de trabajo continuo 2 h.

2699,00 €

Ref.: CA-PRO590M

Ciclo de trabajo continuo 2 h.

1249,00 €

Ref.: CA-PRO200-4MF

Cabezal ALTO RENDIMIENTO

PRO300-K30TF



- 400 V. - 5,5 HP
- 11 Bar - 727 Lt/min
- 1.000 r.p.m.
- 270 Litros



PRO500-7.5TF



- 400 V. - 7,5 HP
- 11 Bar - 875 Lt/min
- 1.200 r.p.m.
- 500 Litros



PRO500-10TF



- 400 V. - 10 HP
- 11 Bar - 1.074 Lt/min
- 1.000 r.p.m.
- 500 Litros



1799,00 €

Ref.: CA-PRO300-K30TF

Cabezal ALTO RENDIMIENTO

2099,00 €

Ref.: CA-PRO500-7.5TF

Cabezal ALTO RENDIMIENTO

2850,00 €

Ref.: CA-PRO500-10TF

Cabezal ALTO RENDIMIENTO

MEZCLADORES Y DECAPADORES

M1202PRO

- 1.200 W.
- Volumen mezcla 40 litros
- 180-400 r.p.m.
- 300-700 r.p.m.
- Regulación electrónica



2 VELOCIDADES

79,00 €

Ref.: CE-M1202PRO

M1600PRO

- 1.600 W
- Volumen mezcla 120 litros
- 210-390 r.p.m.
- 350-650 r.p.m.
- Regulación electrónica



2 VELOCIDADES

99,00 €

Ref.: CE-M1600PRO

M1800PRO

- 1.800 W
- Volumen mezcla 140 litros
- 180-400 r.p.m.
- 300-700 r.p.m.
- Regulación electrónica



2 VELOCIDADES

109,00 €

Ref.: CE-M1800PRO

MB18V

PROFESIONAL

- 350 W. - 18 V.
- Volumen mezcla 120 litros
- 0-3.420 r.p.m.
- 0-710 r.p.m.
- Regulación electrónica



A BATERÍA

DOBLE AISLAMIENTO

199,00 €

Ref.: CE-MB18V

Maleta de plástico incluida

GW1029M

- 2000 W. 50-600 °C
- 2 Velocidades
- 300 - 500 Lt/min.
- 9 accesorios.



35,00 €

Ref.: CE-GW1029M

Maleta de plástico incluida

GW1030M

- 2000 W. 50-600 °C
- 2 Velocidades
- 200 - 500 Lt/min.
- 9 accesorios.



DISPLAY DIGITAL

45,00 €

Ref.: CE-GW1030M

Maleta de plástico incluida

LIJADORAS

PROMOCIÓN

CP31-800 LED + CP31-501

- Lijadora de pared
- 750 W
- Ø Disco lija 225 mm.
- Telescópica: 110/170 cm
- Luz LED
- Plegable

6 VELOCIDADES



- Aspirador para sólidos y líquidos
- 2200 W
- 30 Litros
- Regulación electrónica



**Filtro de agua
TELECOMANDADO**

CP31-900BS

- Lijadora de pared
- 500 W
- Ø Disco lija 225 mm.
- Telescópica: 126/200 cm.
- Plegable

6 VELOCIDADES



399,00 €

CEVIK PRO

**PACK
PINTOR**

225,00 €

CEVIK PRO

Ref.: CP31-900BS

**MOTOR
«BRUSHLESS»**

CP31-1100

- Lijadora de pared
- 1.010 W.
- Ø Disco lija 225 mm.

6 VELOCIDADES



CP31-400

- Lijadora roto orbital
- 230-240 V.
- Ø lija 150 mm.
- 400 - 10000 r.p.m.

ORBITA 5 mm.



CP31-401

- Lijadora roto orbital
- 230-240 V.
- Ø lija 150 mm.
- 400 - 10000 r.p.m.

ORBITA 2,5 mm.



99,00 €

CEVIK PRO

Ref.: CP31-1100

179,00 €

CEVIK PRO

Ref.: CP31-400

**MOTOR
BRUSHLESS**

179,00 €

CEVIK PRO

Ref.: CP31-401

**MOTOR
BRUSHLESS**

HIDROLIMPIADORAS

MPX25EHDS

- 170 Bar
- 500 litros/h
- 2.500 W
- 230V /50 Hz

TOTAL STOP SYSTEM

ACCESORIOS
INCLUIDOS

2 VELOCIDADES



MPX27DTS

- 160 Bar
- 850 litros/h
- 2.700 W
- 230V /50 Hz

TOTAL STOP SYSTEM

ACCESORIOS
INCLUIDOS



MPX30EHB

- 180 Bar
- 600 litros/h
- 3.000 W
- 230V /50 Hz

TOTAL STOP SYSTEM

ACCESORIOS
INCLUIDOS

INDUCCIÓN



169,00 €

Ref.: HI-14752



299,00 €

Ref.: HI-15053



499,00 €

Ref.: HI-15342



MPX150HDC

- 150 Bar
- 630 litros/h
- 3.000 W
- 230V. /50 Hz

ACC. ROTATIVA
Ref.: 41503
OPCIONAL
115€

INDUCCIÓN



MPX230HDR

- 230 Bar
- 900 litros/h
- 7.400 W
- 400V /50 Hz

TRIFÁSICA

ACC. ROTATIVA
Ref.: 41503
OPCIONAL
115€

INDUCCIÓN



MPX240THO

- 240 Bar
- 690 litros/h
- 3.600 W
- 5,5 HP

ACC. ROTATIVA
Ref.: 46149
OPCIONAL
59€



1299,00 €

Ref.: HI-24362



1599,00 €

Ref.: HI-15353



789,00 €

Ref.: HI-15351



MOTOR
HONDA GASOLINA

HIDROLIMPIADORAS

SUPREME90

- 280 Bar
- 960 litros/h
- 13 HP

ACC. ROTATIVA
Ref.: 40964
OPCIONAL
68€



MPX150HL

- 150 Bar
- 500 litros/h
- 2.500 W

TOTAL STOP SYSTEM



MPX200HD

- 200 Bar
- 900 litros/h
- 7.400 W

TOTAL STOP SYSTEM

TRIFÁSICA



2499,00 €

Ref.: HI-27754

MOTOR
HONDA GASOLINA

1599,00 €

Ref.: HI-24332

AGUA
CALIENTE

3750,00 €

Ref.: HI-24335

AGUA
CALIENTE

SISTEMAS DE PROTECCIÓN

AR-142/40F

- Mascarilla de caucho termoplástico
- Con 2 filtros de gas A1 incluidos



AR-142/37F

- Mascarilla de caucho termoplástico
- Con 2 filtros de gas A2P3 incluidos



AR-PCX730

- Mascarilla termoplástico con filtros A1B1E1K1P3 integrados
- Vida útil: 6 meses



11,99 €

Ref.: AR-142/40F

23,00 €

Ref.: AR-142/37F

29,95 €

Ref.: AR-PCX730

SISTEMAS DE ILUMINACIÓN

ESPECIAL
OBRAS

PR30WF

- Proyector LED
- Alcance: 50 m.
- 30W
- 2.600 lúmenes



PR50WF

- Proyector LED
- Alcance: 70 m.
- 50W
- 4.200 lúmenes



PR20WR

- Proyector recargable
- Alcance: 30 m.
- 18W
- 2300 lúmenes



30,05 €

Ref.: EG-PR30WF

XANLITE

45,45 €

Ref.: EG-PR50WF

XANLITE

49,58 €

Ref.: EG-PR20WR

XANLITE

** NUEVO MODELO DISPONIBLE EN ABRIL 2026

** NUEVO MODELO DISPONIBLE EN ABRIL 2026

** DISPONIBLE EN ABRIL 2026

PRAR20WRV23

- Proyector recargable
- Alcance: 30 m.
- 20W
- 2.200 lúmenes



33,05 €

Ref.: EG-PRAR20WRV23

XANLITE

PRAR30W3TRV23

- Proyector recargable
- Alcance: 30 m.
- 30W
- 3.300 lúmenes



41,31 €

Ref.: PRAR30W3TRV23

XANLITE

PR20W2T

- Tripode red de obra con dos focos
- Alcance: 60 m.
- 2 x 20 W
- 2 x 1.600 lúmenes



61,98 €

Ref.: EG-PR20W2T

XANLITE

** NUEVO MODELO DISPONIBLE EN ABRIL 2026

SISTEMAS DE ILUMINACIÓN

**ESPECIAL
OBRAS**

TIRAS LED STRIP REEL

LSE10EXF

- 10 m.
- 3000K - Blanco cálido
- Ø295mm
- 5.600 lúmenes

NOVEDAD



**IP65
Water Resist**

**EXTENSIBLE
70 M.**

XANLITE

49,58 €

Ref.: EG-LSE10EXF

** DISPONIBLE EN ABRIL 2026

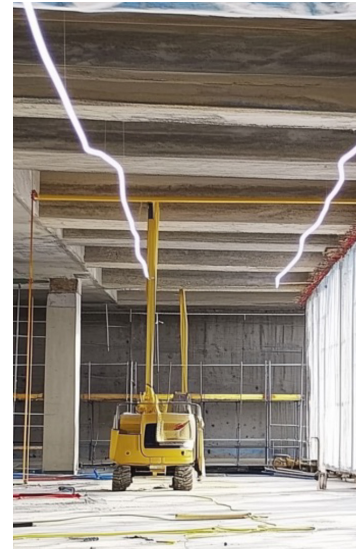

LSE25CWEXF

- 25 m.
- 230 V - 150W
- 15.400 lúmenes
- Duración 25000h
- 6500K - Blanco frío
- Ø295mm
- Incluye kit de fijación (50 piezas)
- PVC



**IP65
Water Resist**

LSE50CWEXF

- 50 m.
- 230 V - 300W
- 30.800 lúmenes
- Duración 25000h
- 6500K - Blanco frío
- Ø300 mm
- Incluye kit de fijación (100 piezas)
- PVC



**IP65
Water Resist**

98,35 €

Ref.: EG-LSE25CWEXF

XANLITE

**EXTENSIBLE
A 75 M.**

164,46 €

Ref.: EG-LSE50CWEXF

XANLITE

**EXTENSIBLE
A 150 M.**

